

GRADEN

INDUSTRIES PTY LTD

SW04

SWING-WING

VERTICUTTER/SCARIFIER

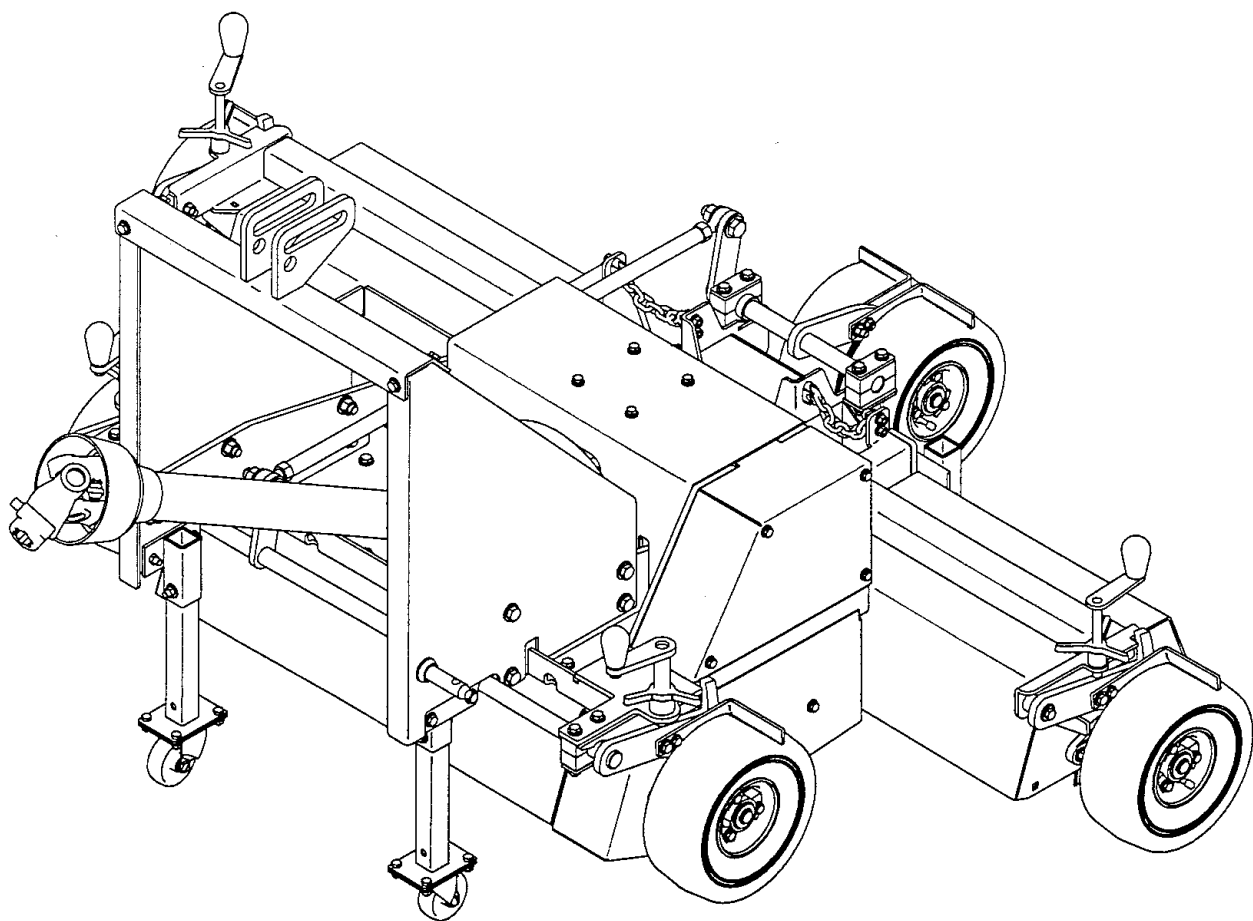

OWNERS MANUAL

GRADEN TURF MACHINERY

Manufactured under licence by

Turf Machinery

1 Waitchie Street

Wedderburn 3518

Victoria Australia

Tel - (03) 5494 3059

Web - gradienturfmachinery.com

Email - turf.engineering@bigpond.com

Contact - Geoff Burnside

Table of Contents

1. Specifications

- 1.1 Specifications
- 1.2 Statement of Machine Use
- 1.3 Serial Number Plate

2. To the Owner

- 2.1 Preliminary instructions
- 2.2 Warning symbols
- 2.3 Servicing the Swing-Wing Verticutter

3. Safety Information

- 3.1 General rules
- 3.2 Training
- 3.3 Personal Protective Equipment (PPE)
- 3.4 Preparation
- 3.5 Operational Safety
- 3.6 Maintenance Safety

4. Assembly Instructions

5. Operating Instructions

- 5.1 Preliminary checks
- 5.2 Set up
- 5.3 Transporting (traversing) the Verticutter
- 5.4 Verticutting
- 5.5 Shut down

6. Maintenance Operations

- 6.1 Adjustments and settings
 - 6.1.1 Rotor belts (centre rotor)
 - 6.1.2 Rotor belts (wing rotors)
- 6.2 Replacements
 - 6.2.1 Blade replacement
 - 6.2.1.1 Centre blade reel
 - 6.2.1.2 Wing blade reels
 - 6.2.2 Belt replacement
 - 6.2.2.1 Rotor belts: centre reel
 - 6.2.2.2 Rotor belts: wing reels
- 6.3 Gearbox
- 6.4 Maintenance schedule

7. Parts & Illustrations

- 7.1 Parts Diagrams
- 7.2 Warning/Compliance Decals

1.1 Specifications

Model	Graden SW04 Swing-Wing Verticutter
P.T.O. Horsepower	20 - 35 h.p.
Drive	Belt drive via Tractor PTO
Gearbox	Comer T27A Increasing Gearbox
Gearbox oil	Gear Oil - SAE 80W90
Cutting Reels	1 Fixed (13 blades), 2 Floating (8 blades ea.)
Cutting width	1520mm (60 inches)
Cutting depth (nominal)	0 to 40mm (maximum with standard blades)
Blades Standard : Optional :	Tungsten carbide tipped spring steel 210mm x 2mm tip Part No. 0232 210mm x 3mm tip Part No. 0217 210mm x 1mm tip Part No. 1122
Blade tip speed	1250m/min (standard blades at normal PTO speed of 540 rpm)
Weight	330 kg
Height	1110 mm (machine on stands)
Overall Width	1980 mm
Length	1330mm
Tyres	4.10/3.50 - 4 Slick Pattern (6 per machine)
Tyre pressure	275 - 345 kPa (40 -50 psi)
Rotor belts	A47 Carlisle Super 2 (8 per machine)

1.2 Statement of Machine Use

The Graden SW04 Swing-Wing Verticutter/Scarifier's main use is as a verticutting/scarifying/de-thatching tool on areas such as golf courses, bowling greens, cricket wickets, tennis courts, and other sporting fields.

It is not for use on turf areas where rocks and other hard foreign bodies may be present. The use of this machine in turf profiles of this nature will likely cause premature wear or shattering of the blade tips and could result in rocks being projected at dangerous speeds, resulting in potential injury to the operator or damage to the machinery.

This machine is not for use in anything other than the soil profiles typically to be found on the sporting fields mentioned above. Any use of this machine in any other type of surface or for any other purpose may void the warranty.

Please contact Graden Industries if you are unsure about your application complying with the intended use of this machine.

1.3 Serial Number Plate

The serial number plate layout is shown below. The serial number is comprised of four sections. The first section is the model number, the second section is the mass of the machine, the third section is the serial number and the fourth section is the year of manufacture of the machine, as indicated below;

GRADEN	
INDUSTRIES PTY LTD	
26 - 28 SCAMMEL STREET	
CAMPBELLFIELD VICTORIA 3061	
MADE IN AUSTRALIA	
MODEL N ^o _____	MASS _____
SERIAL N ^o _____	YEAR _____

2. To the Owner

Read this manual before operating the Swing-Wing Verticutter

2.1 Preliminary Instructions

- It is important that the owner completely familiarises themselves with the contents of this manual
- Keep this manual at hand as a ready reference for anybody using the Graden Swing-Wing Verticutter
- The designed and tested safety features of this machine are dependent on it being operated within the limitations described in this manual

2.2 Warning Symbols

Throughout this manual the following symbols are used to indicate important safety issues. When either or both of these symbols are present the operator must be aware that there is the potential to damage equipment and/or incur serious personal injury.

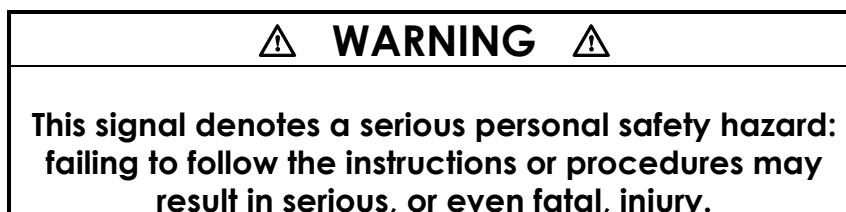
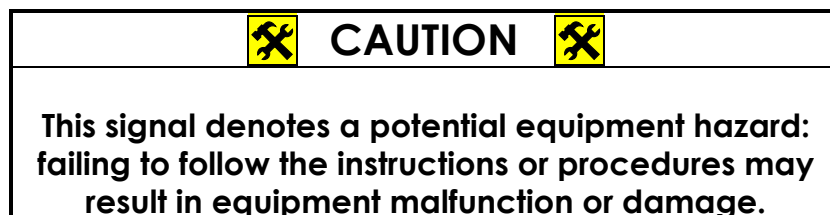

2.3 Servicing the SwingWing Verticutter

The Graden Swing-Wing Verticutter has been carefully engineered and manufactured to provide safe, dependable and effective service.

As with all mechanical equipment it requires routine cleaning and maintenance.

Your authorised Graden representative has access to tools, genuine spares and equipment to service any and all of your requirements.

Use only genuine Graden parts; substitute parts will void the warranty and may not meet the safety and performance standards required for safe and effective operation of the Swing-Wing Verticutter.

Please record the model and serial numbers of the Swing-Wing Verticutter in the space provided below and quote this information when ordering parts or communicating with Graden Industries or its' approved representatives.

Model Number : _____

Serial Number : _____

Date Purchased : _____

3. Safety Information

This manual is provided to help you operate and maintain the Swing Wing Verticutter. Please read it carefully.

It has been compiled from extensive field experience and engineering data.

In some aspects it is generalised because it is impossible to cover all operating scenarios. However, combining the information provided in this manual with your own increasing experience and knowledge with the Swing-Wing Verticutter will enable you to develop procedures suitable for your individual needs.

The Swing-Wing Verticutter, like most modern machinery, is constantly undergoing development on the basis of experience and market needs. At the time of printing, material in this manual was current but may vary due to the aforementioned ongoing development.

Graden Industries reserve the right to change the machinery specifications without notice.

3.1 General Rules

- Direction on the machine (right or left) is determined from standing behind the machine and facing in the direction of forward travel, all directions are given in this manual with this rule in mind
- When viewed from the right side the blades rotate anti-clockwise (counter rotating to the forward rotation of the tractor wheels)
- This is a precision piece of machinery with high speed cutting blades



- Do not allow children to operate the machine or be near it during its' operation.
- Never allow anyone to ride on the Swing-Wing Verticutter at any time.
- Only people who are very familiar with the rules of safe operation should be allowed to use this machine

- Only use the machine during daylight or in good artificial light
- Some illustrations in this manual show the Swing-Wing Verticutter with safety guards removed. This is not a normal situation.

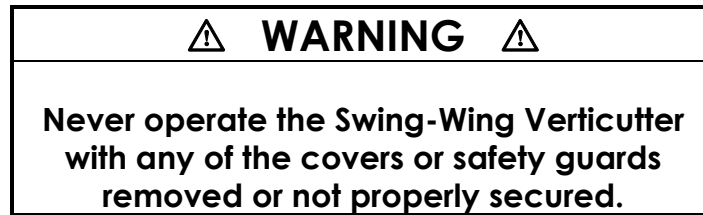

3.2 Training

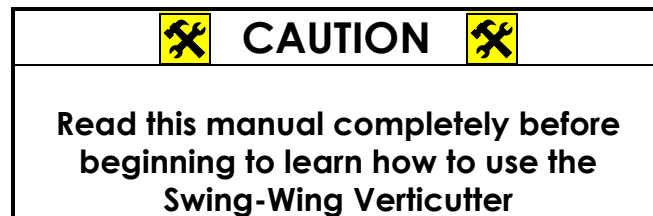

- Do not allow anybody to operate the machine without instruction
- Know your controls and how to stop the machine and shut down the tractor quickly in an emergency
- To maintain control and reduce the possibility of upset, damage or collision, operate the machine smoothly. Avoid erratic operation and excessive speed.
- The tractor has its' own set of safety and operating rules. These must be complied with.



- If the tractor is fitted with a Roll Over Protection Structure (ROPS), do not exceed the ROPS weight certification and always wear your seat belt.
- Be aware of the hazards associated with the tractor engine:
 - ⇒ The fuel used (Petrol, diesel, etc.) is highly flammable so only use an appropriate container
 - ⇒ Never remove the fuel cap or add fuel while the engine is running or still hot
 - ⇒ Never add fuel indoors and wipe up any spillages
 - ⇒ Never run the engine in an enclosed area because exhaust gases are toxic

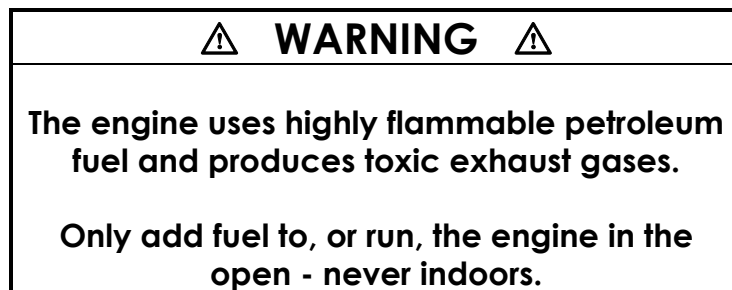

3.3 Personal Protective Equipment (PPE)

- Clothing should be reasonably snug fitting and not free flowing so as to avoid the risk of entanglement in moving parts.
- Wear sturdy footwear, preferably steel capped safety shoes or boots
- Use appropriate PPE for eyes, ears and hands



3.4 Preparation

- Ensure all safety warnings and decals are in place and legible (on both the Swing-Wing and the tractor).
- Ensure that the Swing-Wing Verticutter is correctly mounted on the tractor and that the machine is properly adjusted.

- Remove any accumulated debris that might represent a fire hazard.
- Ensure that the blades are in a serviceable condition and that the rotor shaft mounting bolts are secure.
- Perform any appropriate scheduled maintenance before operating the machine.

3.5 Operational Safety

- Always disengage the P.T.O before attempting to start the tractor.
- Always raise the Swing-Wing Verticutter clear of the turf before attempting to engage the P.T.O.
- Always raise the Swing-Wing Verticutter clear of the ground and disengage the P.T.O when crossing gravel, walkways, roads, etc., or indeed any ground which you do not wish to verticut.
- Be very careful and maintain minimum ground speed when operating over rough ground, around trees, ditches, fences or on sloping ground.



- Never allow anybody in front or behind the tractor and Swing-Wing Verticutter while operating. Before reversing, disengage the P.T.O. then lift the machine clear of the ground and ensure that the area behind you is clear.

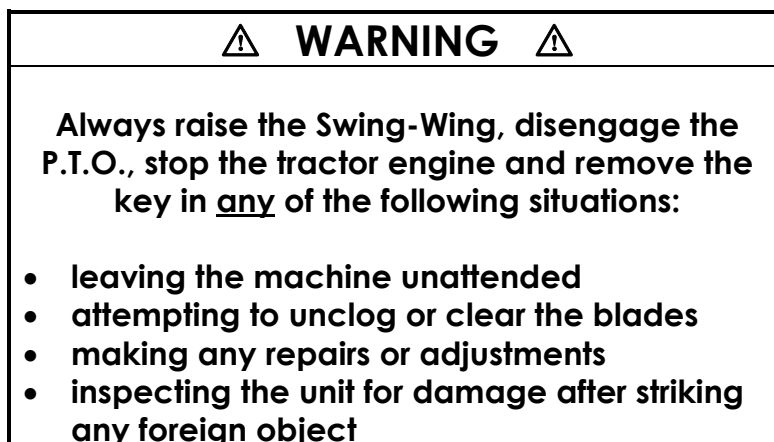

- Always repair any damage before recommencing operation.

3.6 Maintenance Safety

Maintenance on the Swing-Wing Verticutter is best carried out with the machine mounted on the castor wheel-equipped supports that are supplied with the unit.

Alternatively, maintenance can be carried out with the unit mounted on the tractor, so long as it is securely blocked up on jack stands. Do not rely on the tractor hydraulics to maintain the unit at a safe working height.

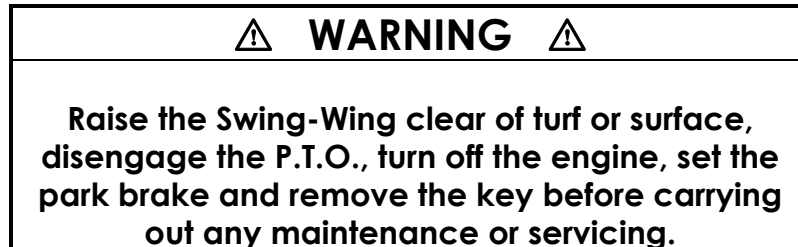

- Never allow anybody near the tractor controls while adjustments, maintenance or servicing are being performed.
- Keep both the Swing-Wing and the tractor (especially around the engine) free of any debris
- Remove debris from underneath the Swing-Wing Verticutter after each use.
- Verify that all warning labels and decals are present, visible and legible.
- Periodically check that all bolts, fasteners and catches are secure and in safe operating condition.
- After any maintenance or servicing, ensure that all guards and safety devices are correctly installed and secure before operating the Swing-Wing Verticutter.

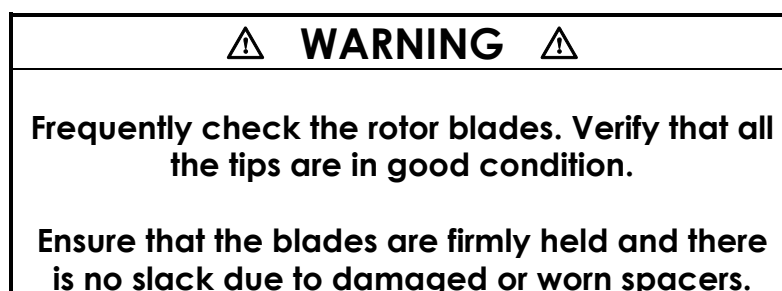

4. Assembly Instructions

Your Verticutter has been manufactured, assembled and tested at Graden Industries before being shipped.

Depending on your local distributor, your Verticutter may be received in the following condition:

- * Left and Right wheel axle assemblies bolted in reverse mounting position (for packing purposes only)
- * Castor wheels removed from supports
- * Left and Right Hand Uprights removed
- * Crossbar removed
- * P.T.O shaft (supplied separate)

As appropriate, please carry out the following assembly instructions (numbers in brackets are part numbers to help identify components in the diagrams);

Tools required : $\frac{1}{2}$ inch AF spanner (x2)
 $\frac{9}{16}$ inch AF spanner (x2)
 $\frac{3}{4}$ inch AF spanner (x2)
 $\frac{15}{16}$ inch AF spanner (x2)
 Large Adjustable spanner

Steps

1. Remove all packaging material and ensure that all documents are present. With each machine should be this manual, and a manual for the PTO Shaft (this may still be attached to the PTO Shaft).
2. Attach Height Connecting Rod (1119) to Rear Wheel Axle (1114), (use $\frac{15}{16}$ inch AF spanners), ensuring the Retaining Chain (1151) is hanging beneath the Height Connecting Rod (1119).
3. Attach the Left and Right Hand Wheel Axle Assemblies (1115 & 1116) to their respective Rotor Housings (1111 & 1112) with the bolts supplied as shown in Diagram Three (use $\frac{9}{16}$ inch AF spanners).
4. Attach the Left and Right Hand Uprights to the Swing-Wing Frame (use $\frac{3}{4}$ inch AF spanners and large adjustable spanner) with the bolts supplied, but do not tighten them up completely.
5. Fit the Crossbar (1118) to the Uprights (1096 & 1097), getting all four bolt and nut sets started in the holes, (use $\frac{9}{16}$ inch AF spanners), but before final tightening of these bolts, tighten up all the bolts for the Uprights (1096/1097) to the Swing-Wing Frame (1110). Now tighten the Crossbar (1118) bolts completely.
6. Fit the Lower Link Pins (5285) onto the Uprights and Base, putting a small amount of Loctite or similar thread sealant onto the thread of the pins before tightening.
7. Remove the screws holding the Front (0622) and Rear (0624) Stands to the pallet then lift the machine from the pallet and attach the Castor Wheels (5299) to the front and rear stands with the bolts supplied (use $\frac{1}{2}$ inch AF spanners).
8. Do a general check of all nuts and bolts on the machine.

Your machine should now be assembled and ready to use.

5. Operating Instructions

⚠ WARNING ⚠

Do not operate the Verticutter until you have completely read this manual.

5.1 Preliminary Checks

1. Clear any debris from above and underneath the machine
2. Ensure scheduled maintenance activities have been completed.
3. Inspect belts for condition and correct tension.
4. Inspect blades for wear or damage.
5. Ensure all guards and covers are firmly fixed in place

5.2 Set Up

1. Ensure that the Swing-Wing is on a firm, level surface
2. Release the four height adjustment locking levers (0970 & 1129) and screw the four height adjustment screws (0986 & 1150) clockwise to lower the wheels as far as they will go.
3. Lock the supports (0622 & 0624) in the raised position so that the Swing-Wing is resting on its' wheel assemblies.
4. Gradually raise the front (1113) and rear (1114) wheel axles so that the centre, fixed blade reel is just about to touch the ground.
5. Gradually raise the left and right hand wheel axles (1115 & 1116) until both of the Swing-Wing blade reels are about to touch the ground.
6. Attach the P.T.O shaft to the Swing-Wing, ensuring the locking pin pops up.
7. Position the tractor in front of the Swing-Wing and lower the tractor 3-point hitch.
8. Attach the lower tractor arms to the lifting pins, secure with 3/8" lynch pins and connect the upper tractor arm to the hole, not the slot, in the crossbar.
9. Adjust the tractor sway bars so that there is no side-to-side motion.
10. Attach the P.T.O. shaft to the tractor, ensuring the locking pin pops up.
11. Secure the P.T.O guard retaining chains at both ends.
12. Raise the Swing-Wing off the ground and verify that the unit is level.
13. This procedure establishes that the Verticutter is level. However this does not ensure that the tractor and its' hitch are even and level. Adjustments may need to be made at the work site to compensate for any variations. This is covered in **5.4**

⚠ WARNING ⚠

The P.T.O retaining chains must be connected to prevent the outer guard from rotating with the P.T.O shaft

5.3 Transporting (Traversing) the SwingWing Verticutter

1. Raise the Swing-Wing just clear of the turf (ground).
2. Ensure the P.T.O. is disengaged.
3. Drive smoothly to your next destination. Avoid excess speed, especially over rough or uneven ground.

5.4 Verticutting

1. Once in position to use the machine, move the upper tractor arm hitch point from the hole to the long slot. Adjust the tractor arm so that it is sitting in the middle of the slot to allow the machine to tilt forward and back with the undulations of the turf.
2. Set the depth of cut via the 4 height adjustment screws (0986 & 1150) to the desired depth. Normal range of cut (with standard 210mm blades) is 0mm to 40mm deep. Clockwise rotation of the screws produces a shallower cut ; anti-clockwise produces a deeper cut. There is an indicator arm on the back of the wheel axles which can help you in setting the heights level.
3. Start the tractor, raise the Verticutter clear of the turf and with the engine at idle gently engage the P.T.O
4. Increase the P.T.O speed to 540 rpm.
5. Gently lower the Swing-Wing into the ground and allow the rotating blades to pull themselves into the turf.
6. Make a test cut on level ground of several metres and check that the Verticutter is cutting to a consistent depth across the full width of the cut.
7. Adjust the fore and aft tilt of the machine and the level on the wings if required.
8. Following these level adjustments, adjust the depth of the cut by altering all the height adjustment knobs by the same amount in the same direction if required.
9. Repeat the short test cut and verify that the cut is even across the Verticutter and that the depth of cut is satisfactory.
10. Forward speed will be determined by such variables as :
 - depth of cut
 - soil hardness
 - moisture content of soil
 - degree of thatch
 - soil texture
 - smoothness of ground, etc..
 - If you are only dethatching then a forward operating speed of 5-10 kmh should be achievable. Deeper cutting will require slower operation. Experience with the machine will establish optimal operating conditions.
11. Steer the tractor in a straight line while the blades are cutting. Trying to change direction while the blades are in the turf may lead to a furrowing/scalping action and can put undue stress on the machine.
12. At the end of a pass:
 - raise the blades just clear of the turf
 - turn the tractor around to make your next run
 - repeat from Step 4 onwards

13. When travelling from area to area raise the blades just clear of the turf and disengage the P.T.O. Drive to avoid unnecessarily bouncing the machine around.

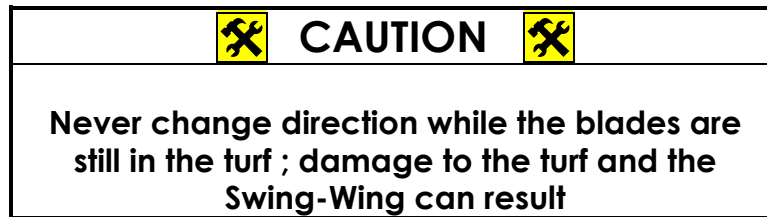

5.5 Shut Down

1. Raise blades just out of turf.
2. Disengage P.T.O.
3. Drop the machine down and remove the top mounting link from the slot and put it back into the hole on the crossbar.
4. Fully raise the Swing-Wing
5. Traverse machine to storage/maintenance area.
6. Generally clean the Swing-Wing Verticutter, making sure that there is no accumulated debris around the blades and P.T.O.
7. Slide front and rear stands down to the lower height so that they protrude below the blades.
8. Lower the machine onto the castor wheels.
9. Disconnect the P.T.O and 3-point linkage arms from the tractor.
10. Wheel the Swing-Wing to its storage area under cover or cover the machine with tarpaulins or other suitable cover if it is to be stored in an uncovered area.

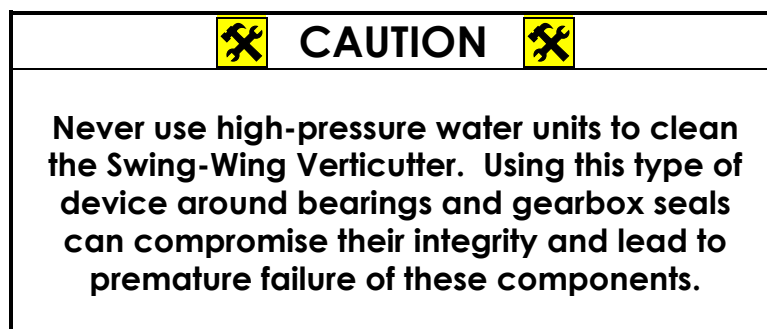

6. Maintenance Operations

The performance of certain maintenance, adjustment or repair operations will be determined by the owner's facilities.

Work can be carried out with the machine supported on the castor wheel mounts supplied with the Swing Wing or, alternatively, with the machine still attached to the tractor.

⚠ WARNING ⚠
If any maintenance operations are carried out with the Verticutter mounted on the tractor, ensure that the unit is supported on jack stands
Do not rely on the tractor hydraulics
Disengage the PTO, turn off the engine and remove the key before proceeding.

⚠ WARNING ⚠
Raise the Swing-Wing clear of turf or surface, disengage the P.T.O., turn off the engine, set the park brake and remove the key before carrying out any maintenance or servicing.

6.1 Adjustments and Settings

The P.T.O. from the tractor drives the gearbox, which in turn drives the blade reels via two sets of drive belts.

6.1.1 Rotor belts (centre rotor)

The central blade reel is driven by a set of three drive belts on the left side of the Swing-Wing.

- Remove the side belt guards (1106 & 1109).
- Adjust the tension by loosening the lock nut on the idler adjuster (0424) and screwing the adjusting nut on the end (clockwise : increases tension; anticlockwise : decreases tension). Re-tighten lock nut.

- **Note** : The recommended tension is 1.0 - 1.5 Kgf (2.2 - 3.3 lbf) to give a deflection of 6mm (1/4 in.) in one of the belts at the mid point between the two pulley centres. This force is approximately the maximum that can comfortably be applied using just the index finger.
- Re-fit the belt guards

6.1.2 Rotor belts (wing rotors)

The rear, Swing-Wing blade reels are driven by a set of five belts that come off the gearbox (5134) to a central pulley (0418). This pulley is connected to the Swing-Wing blade reels via universal joint assemblies (5141).

Tension is maintained by a wide idler pulley (0421) that is located behind the gearbox, under the gearbox cover (1108).

- Remove the Gearbox Cover (1108).
- Loosen the long bolt through the long idler pulley (0421) until there is just enough tension to hold the idler pulley in place.
- Tap the idler pulley forward in the slots with a plastic mallet or similar tool until sufficient tension is being applied to the five belts.
- Re-tighten the long bolt.
- Re-fit the Gearbox Guard.

If, due to belt stretch, there is no adjustment left to be able to slide the long idler pulley forward, you can re-position the idler brackets to increase the tension:

- Loosen the idler pulley bolt completely and slide it to the rear of the slots.
- Loosen the bolts holding the idler brackets (0385) and slide them forward; ensure that the two brackets are moved an equal amount so an even pressure will be applied to all five belts. Re-tighten these brackets.
- Push the long idler pulley forward and re-tension the belts as above.
- if there is still insufficient adjustment left to achieve sufficient tension on the belts, then the belts need to be replaced (see **6.2.2.2**).

6.2 Replacements

These operations are best carried out with the Verticutter mounted on the supplied castor wheel supports but can be done with the unit still attached to the tractor.

⚠ WARNING ⚠
If any maintenance operations are carried out with the Verticutter mounted on the tractor, ensure that the unit is supported on jack stands
Do not rely on the tractor hydraulics
Disengage the PTO, turn off the engine and remove the key before proceeding.

6.2.1 Blade replacement

6.2.1.1 Centre blade reel

1. Fit the front and rear stands to the Verticutter using the highest hole in the support.
2. Remove side belt guards (1106 & 1109)
3. Slacken idler arm adjuster (0424) to remove all tension on belts
4. Remove belts (5143) from the rotor shaft pulley (5128)
5. Loosen the grub screw from the eccentric locking collar on the bearing (5088) at the right end of the rotor shaft and tap the locking collar in the opposite direction to which it has been locked. Remove the collar.
Note: These eccentric locking collar bearings are always locked in an opposite rotation to the travel of the rotor shaft during assembly at the factory.
6. Undo the bolts holding the bearings (5025 & 5088) at each end of the blade reel.
7. Allow the right bearing (5088) to slide along the rotor shaft (0134) to provide some free movement and gently allow the blade reel to drop free from the machine.
Note : Take care to perform this operation with a protective layer under the machine (old carpet is ideal) to protect the blade tips from any hard surface.
8. Push the Verticutter clear of the blade reel.
9. Slide the right end bearing (5088) from the end of the rotor shaft (0134).
10. Remove the right Nyloc nut (5089) and rotor shaft washer (0039) from the rotor shaft (0134).
11. Remove blades (0232) and spacers from the shaft.
Replace blades and spacers as required, ensuring that the blades go

- back on the shaft in the same direction and configuration (i.e. counter-rotating to direction of forward travel and successive blades offset one face on the rotor shaft).
12. Loosely re-position the bearing (5088) on the right end of the blade reel and place the reel back under the Verticutter.
 13. Position the bearing housing so that the grease nipple is pointing up and securely bolt the blade reel in place.
 14. Re-fit the eccentric collar on the right bearing of the blade reel.
 15. Re-fit rotor drive belts.
 16. Re-tension the idler pulley adjustment as per **6.1.1**
 17. Re-fit belt guards.

6.2.1.2 Wing blade reels

1. Fit the front and rear stands to the Verticutter using the highest hole in the support.
2. Loosen the grub screw from the eccentric locking collar on the bearing (5088) at the outer end of the rotor shaft and tap the locking collar in the opposite direction to which it has been locked, remove the collar.
3. Loosen the grub screws of the inner rotor shaft bearing (5025).
4. Undo the bolts holding the bearings (5025 & 5088) at each end of the blade reel.
5. Allow the outer bearing (5088) to slide along the rotor shaft to provide some free movement and gently allow the blade reel to drop free from the rotor housing. The reel is still attached to the machine at the universal joint end.
Note: Take care to perform this operation with a protective layer under the machine (old carpet is ideal) to protect the blade tips from any hard surface.
6. Slide the outer bearing from the end of the rotor shaft (0047).
7. Remove the Nyloc nut (5089) and rotor shaft washer (0039) from the outer end of the rotor shaft.
8. Remove blades (0232) and spacers from the shaft.
Replace blades and spacers as required, ensuring that they go back on the shaft in the same direction and configuration (i.e counter rotating to direction of forward travel and successive blades offset one face on the rotor shaft). Replace rotor shaft washer and nyloc nut.
9. Loosely re-position the bearing on the outer end of the blade reel and swing the reel back into the rotor housing.
10. Position the bearings so that the grease nipples are accessible (outer bearing, up; inner bearing, down). Tighten the outer bearing bolts (5088) fully back onto the wing housing. When fitting the inner bearing (5025) back onto the wing housing you must leave it a little bit 'loose' to allow a small amount of freedom for the universal joint in case of any minor misalignment. The easiest way to 'loosen' these bolts is to tighten them on fully, then back each bolt off about $\frac{1}{2}$ to $\frac{3}{4}$ a turn of the spanner.

11. You now need to hit both bearing housings quite hard with a plastic mallet. This is to 'seat' the shafts and bearings again to avoid any misalignment of the shaft with the bearings.
12. Re-tighten the grub screws on the inner bearing.
13. Re-fit the locking collar on the outer end of the rotor shaft
14. Verify that the blades are facing forward and counter rotate to the direction of normal forward motion.

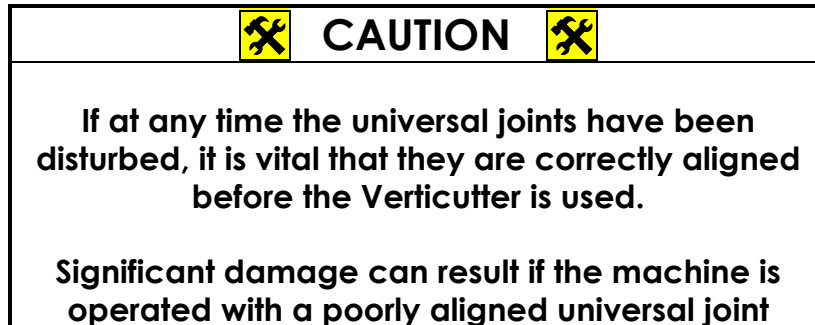

- Note :**
- a. The universals are individually fitted and so must go back in their original position using the same keys
 - b. The two wing blade reels are mirror images; the blades go on the rotor shaft in opposite directions. If, at any time, both blade reels are removed from the machine at the same time, be careful to return each shaft to its' original position and that the blade orientation is correct.

6.2.2 Belt Replacement

Note: Most of the stretch that the belts experience takes place in the first few hours under load conditions after they have been first installed. After fitting new belts it is advisable that the tension be checked during the first 3 to 4 hours of operation.

6.2.2.1 Rotor belts : centre reel

1. Fit the front and rear stands to the Verticutter using the highest hole in the support.
2. Remove side belt guards (1106 & 1109).
3. Slacken idler arm adjuster (0424) to remove all tension on the belts.
4. Remove belts from rotor shaft pulley (5128).
5. Fit new belts.
6. Adjust tension on the idler arm adjuster as per **6.1.1**
7. Re-fit guards.

6.2.2.2 Rotor belts : wing reels

1. Fit the front and rear stands to the Verticutter using the highest hole in the support.
2. Remove the gearbox cover (1108).
3. Take all tension off the belts by loosening the idler pulley mechanism completely from the main frame of the Maxi-Wing.

4. Cut the old belts off the pulleys.
5. Remove the bottom belt cover (0372) and the left hand drive cover (0500).
6. Loosen the grub screws on the 1" bearings that support the 5-belt pulley (0418) on the left hand side.
7. Unbolt this bearing and slide it towards the five belt pulley as far as it will go.
8. Loosen the grub screws on the two bearings holding the rotor shaft in the left hand rotor housing (1111) and move the bearings away from the housing slightly.
9. Lower the reel assembly out of the housing.
10. You can now feed the five new belts over the blade reel and universal joint, past the bearing on the left hand side pulley hub (0153) and onto the 5 groove pulley (0418). Just leave them hanging on the pulley at this stage.
11. Now bolt the rotor shaft bearings and pulley hub bearing back into place, making sure that the 5 groove pulley bearing is as high as possible in its mounting holes (this will make it easier to fit the belts over both five groove pulleys), then tighten the bolts and grub screws up. VERY IMPORTANT: On the inner bearing (5025) on the rotor housing (1111) you must back the bolts off $\frac{1}{2}$ to $\frac{3}{4}$ of a turn after tightening, to allow the universal joint some free movement.
12. You are now ready to refit the belts. You must start with the two on the left of the pulley. These two must be fed over the large pulley (5130) and placed between the large pulley and the gearbox. Now feed the 2nd from left belt into the 2nd from left groove on the bottom pulley first. Then ease the belt over the left most groove of the large pulley up top, then ease it again over to the 2nd from left groove. It is now in the correct groove.
13. Now fit the left most belt into the left most groove of the bottom pulley, then into the top pulley in the corresponding groove.
14. The other three belts are treated similarly, making sure you start with the middle belt in the bottom middle groove first, then ease it on one groove at a time in the top pulley until it is in the corresponding groove. Repeat for the last two belts.
15. Refit the Idler Pulley mechanism and tension the belts up (new belts should not need much adjustment initially, but be sure to check them regularly for belt stretch in the first few hours of operation and re-tension as required).
16. Re-fit bottom belt cover (0372), drive cover (0500) and the gearbox cover (0328) and you are done.

6.3 Gearbox

The gearbox should not require servicing. Annual checking of the oil level and oil quality should be all that is required. If topping up is required then use Gear Oil SAE 80W90.

6.4 Maintenance Schedule

After first 4 hours :

- Check tension on centre blade reel belts; adjust as per **6.1.1**
- Check tension on wing blade reel belts; adjust as per **6.1.2**
- Generally check for any loose nuts or fittings, especially blade reel retaining bolts

Daily : Before Use

- Check for worn, slipping or damaged belts
- Check for even tyre pressure (max. 345 kPa; 50 psi)
- Check for worn or damaged blades
- Check for any loose nuts, bolts and fasteners
- Ensure all guards are securely in place

Daily : After Use

- Clear rotor blades of any debris
- Clear any debris generally, especially from around PTO shaft

Every 40 Hours

- Grease rotor shaft bearings
- Grease universal joints
- Grease PTO shaft splines

Every 6 Months

- Grease all bearings
- Check all belts for wear and tension; replace if necessary

Every 12 Months

- Annual service should thoroughly check all of the above.
- Check oil level and oil quality in gearbox.
- Recommend changing all belts if this hasn't already been done, unless belts appear to be in good condition and will last another twelve months.



CAUTION



Never use high-pressure water units to clean the Swing-Wing Verticutter. Using this type of device around bearings and gearbox seals can compromise their integrity and lead to premature failure of these components.

DIAGRAM ONE

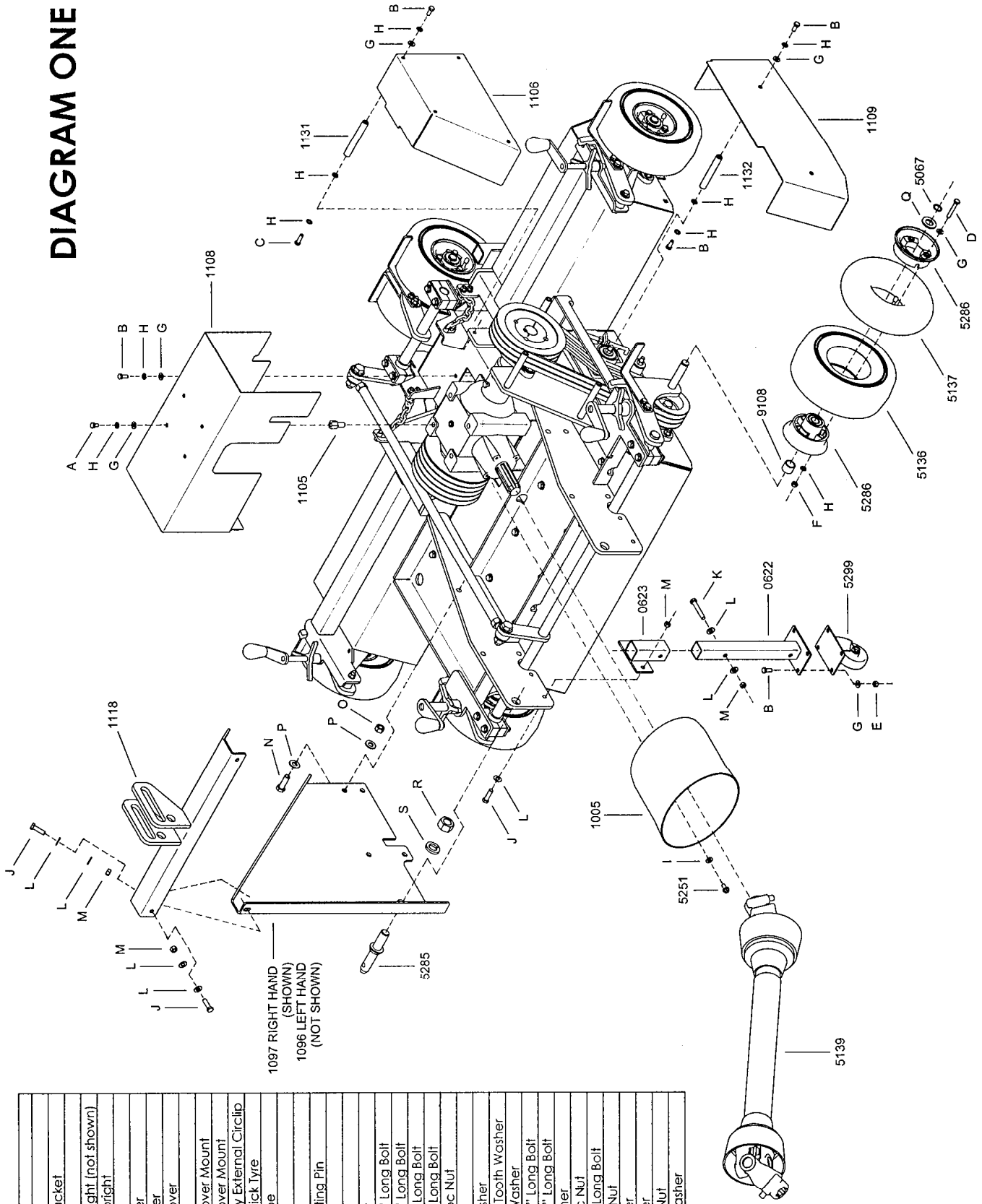

Part Number	Description
0622	Side Stand
0623	Side Stand Bracket
1005	Shroud
1096	Left Hand Upright (not shown)
1097	Right Hand Upright
1105	Cover Spacer
1106	Top Side Cover
1108	Gearbox Cover
1109	Lower Side Cover
1118	Crossbar
1131	Upper Side Cover Mount
1132	Lower Side Cover Mount
5067	3/4" Heavy Duty External Circlip
5136	4.10 x 3.50-4 Slick Tyre
5137	4.10 x 3.50 Tube
5139	PTO Shaft
5251	Flanged Bolt
5285	Bolt On Mounting Pin
5286	Alloy Rim
5299	Castor Wheel
9108	Wheel Spacer
A	5/16" UNF x 1/2" Long Bolt
B	5/16" UNF x 3/4" Long Bolt
C	5/16" UNF x 1" Long Bolt
D	5/16" UNF x 2" Long Bolt
E	5/16" UNF Nyloc Nut
F	5/16" Hex Nut
G	5/16" Flat Washer
H	5/16" Internal Tooth Washer
I	5/16" Spring Washer
J	3/8" UNF x 1 1/4" Long Bolt
K	3/8" UNF x 2 1/4" Long Bolt
L	3/8" Flat Washer
M	3/8" UNF Nyloc Nut
N	1/2" UNF x 1 1/2" Long Bolt
O	1/2" UNF Nyloc Nut
P	1/2" Flat Washer
Q	3/4" Flat Washer
R	7/8" UNF Hex Nut
S	7/8" Spring Washer

DIAGRAM TWO

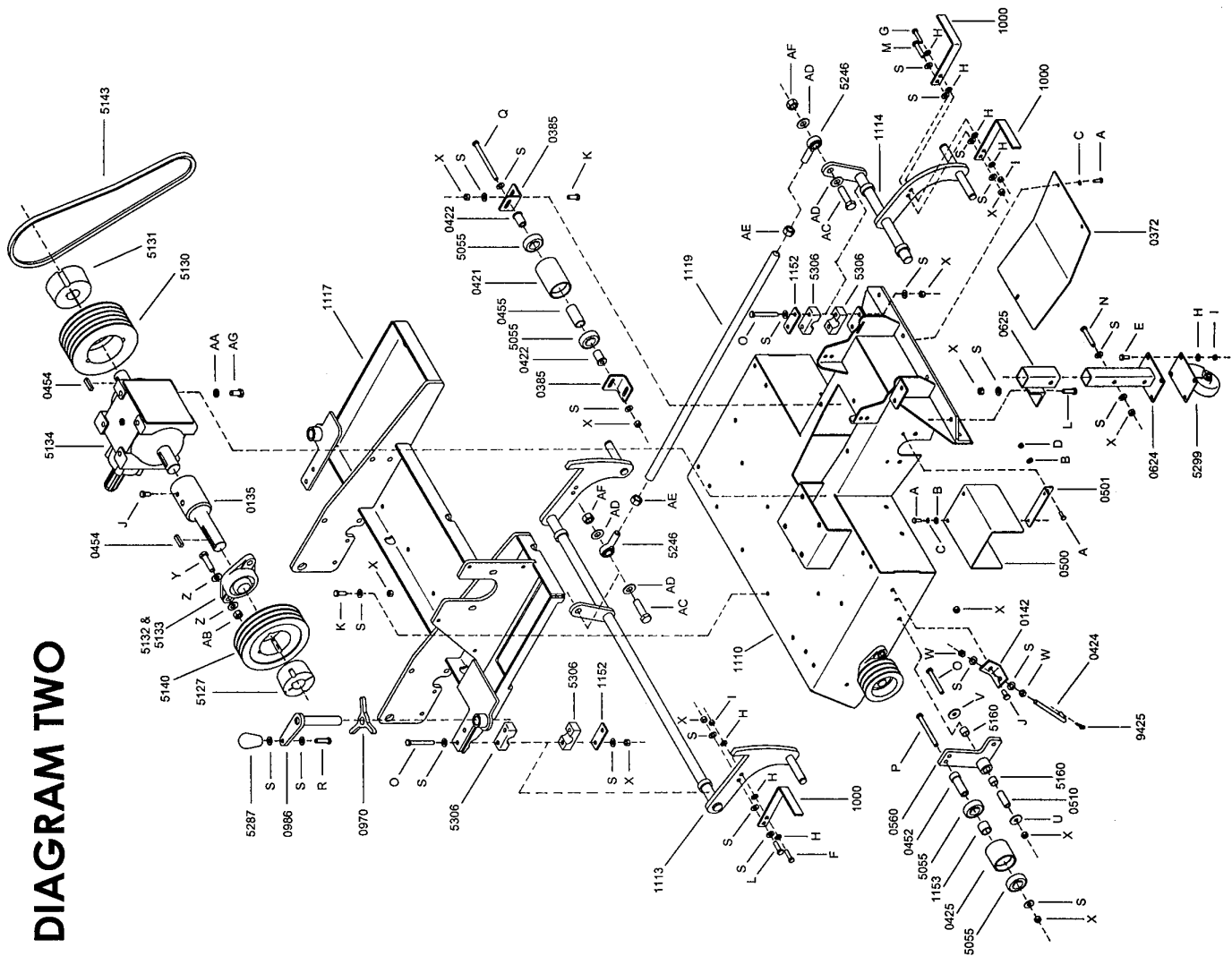

Part Number	Description	Item Number	Description
0135	Extension Shaft	A	1/4" UNF x 3/4" Long Bolt
0142	Idler Adjuster Bracket	B	1/4" Flat Washer
0372	Bottom Belt Cover	C	1/4" Internal Tooth Washer
0385	Idler Bracket	D	1/4" UNF Nyloc Nut
0421	Idler Tube - Long	E	5/16" UNF x 1 1/2" Long Bolt
0422	Idler Bush	F	5/16" UNF x 1 1/2" Long Bolt
0424	Idler Adjuster	G	5/16" UNF x 1 1/2" Long Bolt
0425	Idler Tube - Short	H	5/16" Flat Washer
0452	Side Idler Bush	I	5/16" UNF Nyloc Nut
0454	8mm x 10mm Key	J	3/8" UNF x 3/4" Long Bolt
0455	Idler Spacer Bush	K	3/8" UNF x 1" Long Bolt
0500	Drive Cover	L	3/8" UNF x 1 1/2" Long Bolt
0501	Mount Angle	M	3/8" UNF x 1 3/4" Long Bolt
0510	Bush	N	3/8" UNF x 2 1/2" Long Bolt
0560	Heavy Duty Idler Arm	O	3/8" UNF x 3" Long Bolt
0624	Rear Stand	P	3/8" UNF x 4" Long Bolt
0625	Rear Stand Bracket	Q	3/8" UNF x 5" Long Bolt
0970	Locking Lever	R	3/8" UNC x 1 1/2" Long Bolt
0986	Height Adjustment Screw	S	3/8" Flat Washer
1000	Scraper	T	3/8" High Tensile Washer
1110	Swing-Wing Frame	U	3/8" x 1 1/4" Guard Washer
1113	Front Wheel Axle	V	3/8" x 1 7/8" Guard Washer
1114	Rear Wheel Axle	W	3/8" UNF Hex Nut
1117	Top Plate	X	3/8" UNF Nyloc Nut
1119	Height Connecting Rod	Y	1/4" UNF x 2" Long Bolt
1152	Axle Clamp Plate	Z	1/4" Flat Washer
1153	Short Bearing Spacer	AA	1/2" Spring Washer
5055	Bearing	AB	1/4" UNF Nyloc Nut
5127	2517 - 35mm Taper Lock Hub	AC	5/8" UNF x 2 1/4" Long Bolt
5130	180mm Taper Lock Pulley - 5 Belt	AD	5/8" Flat Washer
5131	3120 - 35mm Taper Lock Hub	AE	5/8" UNF Hex Nut
5132	35mm Bearing	AF	5/8" UNF Nyloc Nut
5133	Bearing Housing	AG	M12 x 25mm Long Bolt
5134	Gearbox		
5140	180mm Taper Lock Pulley - 3 Belt		
5143	Drive Belt		
5160	Bronze Sintered Bush		
5246	5/8" Rod End - Male		
5287	Lever Knob		
5299	Castor Wheel		
5306	Axle Clamp		
9425	2mm R-Clip		

DIAGRAM THREE

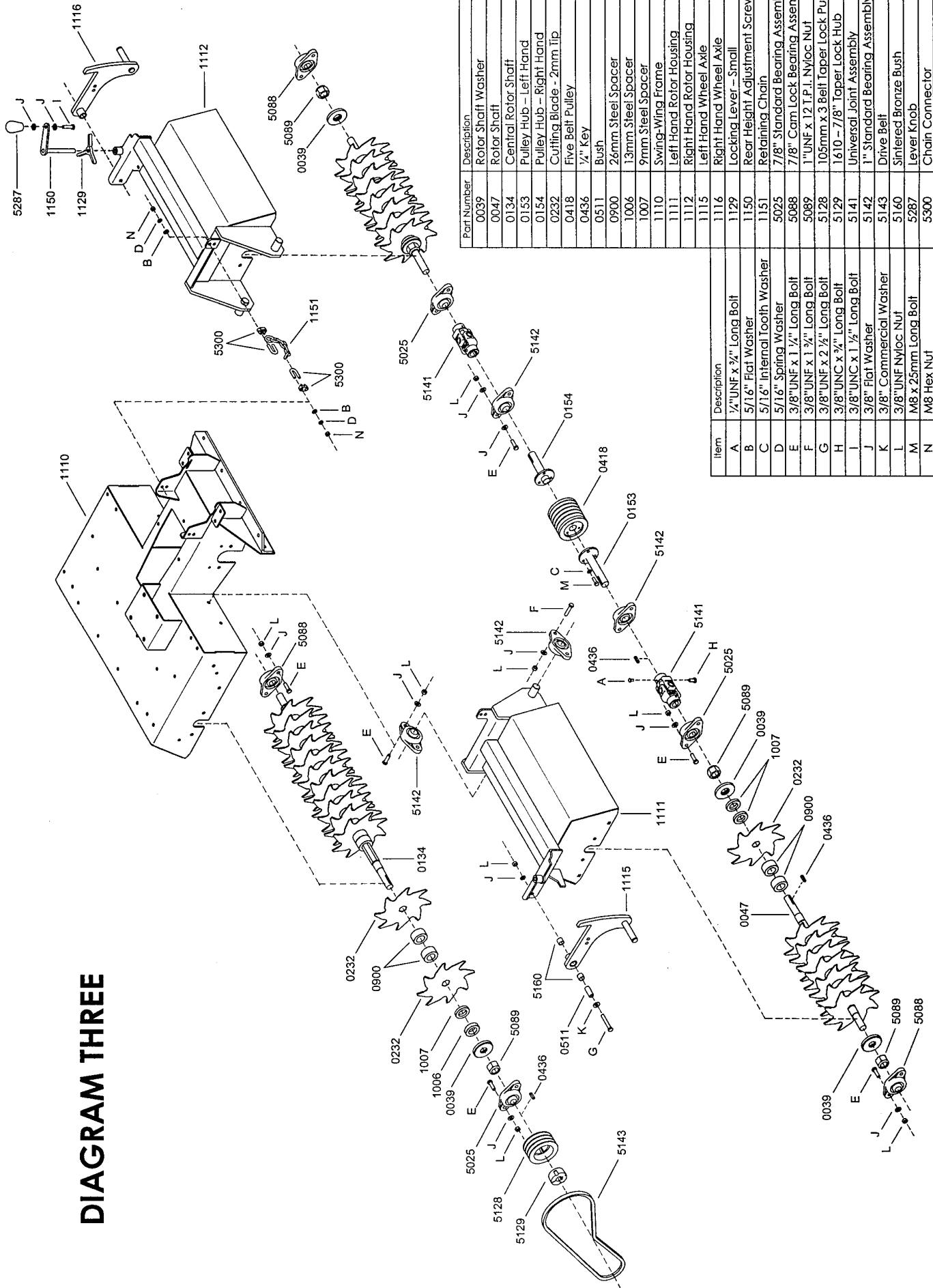

Part Number	Description
0039	Rotor Shaft Washer
0047	Rotor Shaft
0134	Central Rotor Shaft
0153	Pulley Hub - Left Hand
0154	Pulley Hub - Right Hand
0232	Cutting Blade - 2mm Tip
0418	Five Belt Pulley
0436	1/2" Key
0511	Bush
0900	26mm Steel Spacer
1006	13mm Steel Spacer
1007	9mm Steel Spacer
1110	Swing-Wing Frame
1111	Left Hand Rotor Housing
1112	Right Hand Rotor Housing
1115	Left Hand Wheel Axle
1116	Right Hand Wheel Axle
1129	Locking Lever - Small
1150	Rear Height Adjustment Screw
1151	Retaining Chain
5025	7/8" Standard Bearing Assembly
5088	7/8" Cam Lock Bearing Assembly
5089	1" UNF x 12 T.P.I. Nyloc Nut
5128	105mm x 3 Belt Taper Lock Pulley
5129	1610 - 7/8" Taper Lock Hub
5141	Universal Joint Assembly
5142	1" Standard Bearing Assembly
5143	Drive Belt
5160	Sintered Bronze Bush
5287	Lever Knob
5300	Chain Connector

Item	Description
A	1/2" UNF x 3/4" Long Bolt
B	5/16" Flat Washer
C	5/16" Internal Tooth Washer
D	5/16" Spring Washer
E	3/8" UNF x 1 1/4" Long Bolt
F	3/8" UNF x 1 3/4" Long Bolt
G	3/8" UNF x 2 1/2" Long Bolt
H	3/8" UNC x 3/4" Long Bolt
I	3/8" UNC x 1 1/2" Long Bolt
J	3/8" Flat Washer
K	3/8" Commercial Washer
L	3/8" UNF Nyloc Nut
M	M8 x 25mm Long Bolt
N	M8 Hex Nut



PART NO. 5312 – Cover Warning Decal (x3)



PART NO. 5154 – Danger Decal (x7)

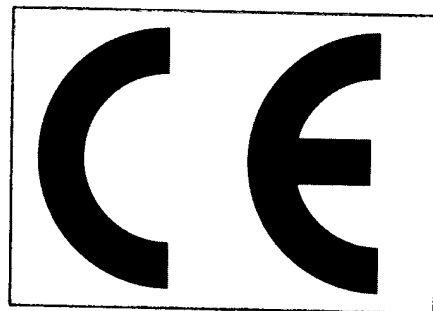

PART NO. 5179
CE Decal